

CONTENTS

This section contains miscellaneous door hardware.

TABLE OF CONTENTS:

Saddle Entry Sets	Page	26-2
Rim Lock Sets	Page	26-3
Squash Court Flush Ring Pull	Page	26-4
Blind Mount Sets	Page	26-5

ORDERING INSTRUCTIONS:

Complete Sets: Always provide quantity, item number, lever/knob number, function, patina, door handing, backset and door thickness.

*Example of order for 802 Series handle x lever double cylinder Complete Handle Entry Set.

QTY	ITEM#/LEVER#	FUNCTION	PATINA	HANDING	BACKSET	THICKNESS
1	CS-2500/K237	Single Cylinder	W3	RH	2 3/4"	2 1/4"

Trim Sets: Always provide quantity, item number, lever/knob number, lock manufacturer, model number, and cylinder type, patina, handing, backset, and thickness.

*Example of order for 601 Series handle x lever Trim Only Mortise Lock Entry Set.

QTY	ITEM#/LEVER#	FUNCTION	PATINA	HANDING	BACKSET	THICKNESS
1	TS-2500/K237	Baton #1820LL-RH Cylinder #1530182	S2	RH	2 1/2"	2 1/4"

Custom Sets: See Custom Ordering Instructions in the General Information section at front of binder.

DOOR HANDING GUIDE:

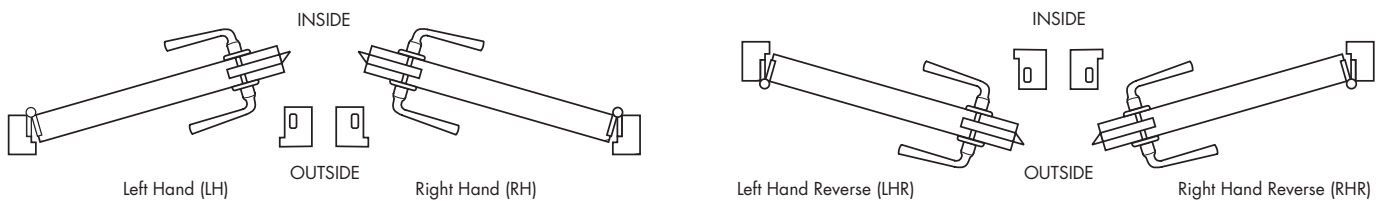

Revised 03/24/11



2500 SADDLE ENTRY SETS

Illustrations are for demonstration purposes only.

Note: Includes escutcheon plate. Available knob or lever high or low.

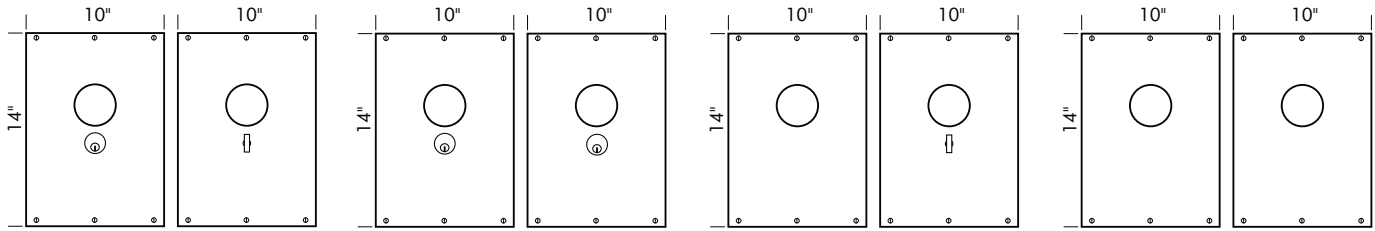

CS-2500ML

- Complete set with mortise lock, cylinder and spindle.
- Single cylinder.
- Shown with K-237 knob.
- No key cover.
- OR
- TS-2500ML**
- Trim set only. No lock.

CS-2500ML-DC

- Complete set with mortise lock, cylinders and spindle.
- Double cylinder.
- Shown with K-237 knob.
- No key cover.
- OR
- TS-2500ML-DC**
- Trim set only. No lock

CS-2500ML-PF

- Complete set with mortise lock and spindle.
- Patio function.
- Shown with K-237 knob.
- OR
- TS-2500ML-PF**
- Trim set only. No lock.

TS-2500ML-FD

- Trim set only.
- Full dummy.
- Shown with K-237 knob.

Complete sets with cylinder(s), spindle and emergency egress mortise lock (except where noted non-egress).

- CS-2500ML** Single cylinder. Knob x knob or lever x lever. Wrap around escutcheon plate.
- CS-2500ML-DC** Double cylinder. Non-egress.
- CS-2500ML-PF** Patio function.
- TS-2500ML-FD** Full dummy. No key cover or turn piece.

Requires 2 1/4" minimum door thickness.
 Additional functions and custom backsets available. Call for options and pricing.
 Door handing and thickness is required for all Lever/Knob Mortise Lock Entry Sets.
 Always specify lever/knob design.

Trim sets for mortise lock, with spindle, no lock or cylinder(s) included.

- TS-2500ML** Single cylinder. Knob x knob or lever x lever. Wrap around escutcheon plate.
- TS-2500ML-DC** Double cylinder. Non-egress.
- TS-2500ML-PF** Patio function.
- TS-2500ML-FD** Full dummy. No key cover or turn piece.

Specify manufacturer and function of lock to be used.
 Door handing and thickness is required for all Lever/Knob Mortise Lock Entry Sets.
 Always specify lever/knob design.

PROPRIETARY AND CONFIDENTIAL: The information contained in this drawing is the sole property of Sun Valley Bronze. Any reproduction in part or as a whole without the written permission of Sun Valley Bronze is prohibited.

Revised 03/24/11



Illustrations are for demonstration purposes only.

Note: Includes escutcheon plate. Available with any knob or lever.

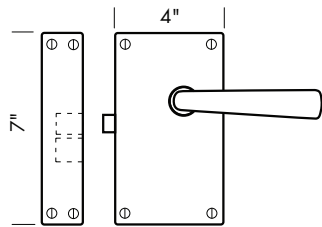

CS-RL300-PA
-Complete rim lock with spindle.
-Passage set.
-Shown with L-106 lever.

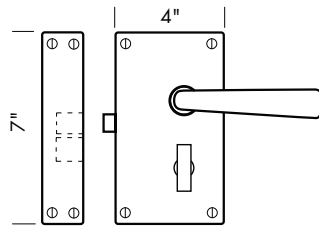

CS-RL300-PR
-Complete rim lock with spindle.
-Privacy set.
-Shown with L-106 lever.

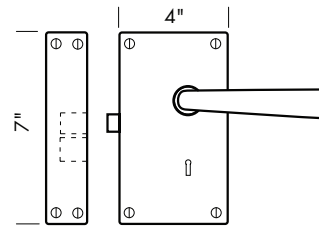

CS-RL300-BK
-Complete rim lock with bit key and spindle.
-Shown with L-106 lever.

Complete sets with cylinder(s), spindle and emergency egress mortise lock (except where noted non-egress).

CS-RL300-PA Passage set.

CS-RL300-PR Privacy set.

CS-RL300-BK Bit key.

Available for any door thickness.

Additional functions and custom backsets available. Call for options and pricing.

Door handing and thickness is required for all Rim Lock Sets.

Always specify lever/knob design.

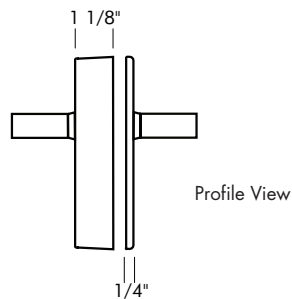

PROPRIETARY AND CONFIDENTIAL: The information contained in this drawing is the sole property of Sun Valley Bronze. Any reproduction in part or as a whole without the written permission of Sun Valley Bronze is prohibited.

Revised 03/24/11



SQUASH COURT FLUSH RING PULL

Illustrations are for demonstration purposes only.

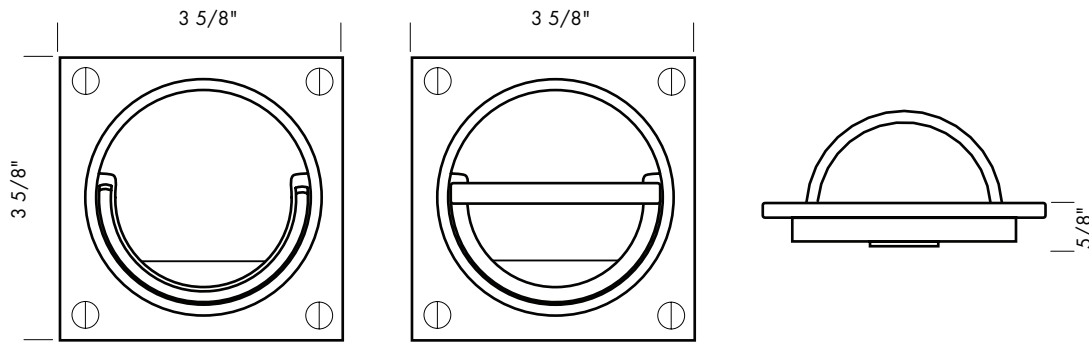

SQFP-358

Squash court flush ring pull.

SQFP-358 Flush pull. 3 5/8" x 3 5/8" x 5/8" thick.
3/8" interior depth

Can be made as a pull or to operate a latch. Please specify.
Surface mount on 1 3/4" thick doors.
Can be flush mounted on 2 1/4" doors or thicker.

PROPRIETARY AND CONFIDENTIAL: The information contained in this drawing is the sole property of Sun Valley Bronze. Any reproduction in part or as a whole without the written permission of Sun Valley Bronze is prohibited.

Revised 03/24/11



Illustrations are for demonstration purposes only. Any lever or knob may be substituted for lever or knob shown.

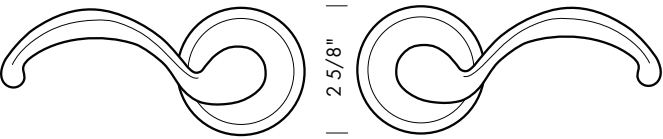

TS-RP402BM
Shown with L-120 lever.

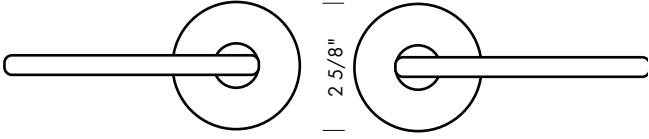

TS-RP926BM
Shown with L-129 lever.

Blind mount sets.

- TS-RP402BM Blind mount set with internal fastening system and spring assist. 2 5/8" round plate.
- TS-RP926BM Blind mount set with internal fastening system and spring assist. 2 5/8" round plate.

Minimum 1 3/8" doors or thicker.
Always specify lever/knob design.

SUN VALLEY BRONZE

PROPRIETARY AND CONFIDENTIAL: The information contained in this drawing is the sole property of Sun Valley Bronze. Any reproduction in part or as a whole without the written permission of Sun Valley Bronze is prohibited.

Revised 03/24/11

