

## CONTENTS

This section contains Casement and Multi-point Window Retrofit Hardware. All window Retrofit Sets include spindle, fasteners, and installation instructions.

### TABLE OF CONTENTS:

<u>Casement Window Hardware</u>	Pages	<u>20-2 - 20-6</u>
<u>Sash Lock</u>	Page	<u>20-7</u>
<u>Multi-Point Window Hardware</u>	Page	<u>20-8 - 20-10</u>
<u>Multi-Point Lever Options</u>	Page	<u>20-11 - 20-12</u>

### ORDERING INSTRUCTIONS:

**Casement Window Hardware:** Always provide quantity, item number, window manufacturer, and patina.

**Multi-Point Window Hardware:** Always provide quantity, item number, lever number, window manufacturer, patina, and handing.

\* Example of order for MPW -200 Multi-Point Window Set

QTY	ITEM#/KNOB#	MANUFACTURER	PATINA	HANDING
3	MPW -200/L-93	Pozzi	S2	RH

**Custom Sets:** See Custom Ordering Instructions in the General Information section at front of binder.

### WINDOW LATCH HANDING GUIDE:

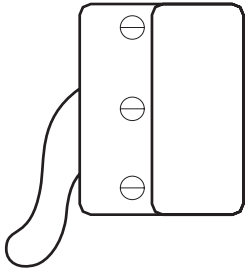

Left Hand (LH)

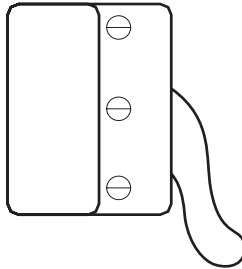

Right Hand (RH)

**PROPRIETARY AND CONFIDENTIAL:** The information contained in this drawing is the sole property of Sun Valley Bronze. Any reproduction in part or as a whole without the written permission of Sun Valley Bronze is prohibited.

Revised 03/10/11



SUN VALLEY BRONZE

# CASEMENT WINDOW HARDWARE

SUN VALLEY BRONZE

Illustrations are for demonstration purposes only.

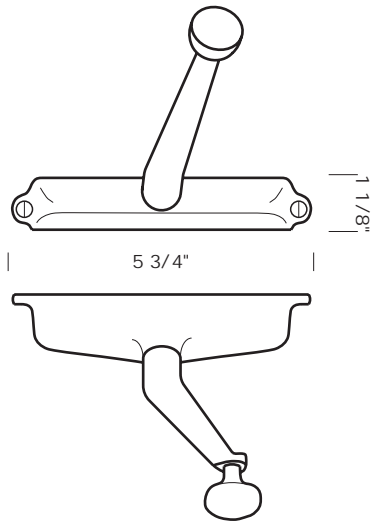

CWC-100 Window crank and cover.  
Compatible with Truth window mechanism. (Not included).  
Cover mounts directly to window jamb.

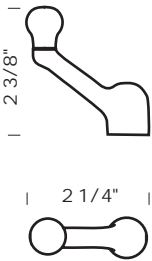

CWH-50 Window crank for casement windows.  
Compatible with Truth window mechanism. (Not included).

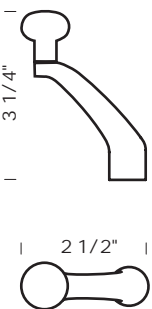

CWH-100 Window crank for casement windows.  
Compatible with Truth window mechanism. (Not included).

\* Always specify window manufacturer.

**PROPRIETARY AND CONFIDENTIAL:** The information contained in this drawing is the sole property of Sun Valley Bronze. Any reproduction in part or as a whole without the written permission of Sun Valley Bronze is prohibited.

Revised 03/10/11



# CASEMENT WINDOW HARDWARE

Illustrations are for demonstration purposes only.

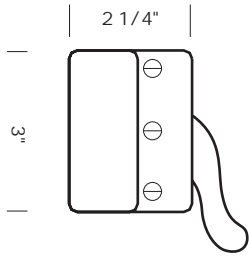

CWL-100RH Right hand window latch and strike.  
Compatible with Truth window mechanism. (Not included).  
Latch mounts directly to window jamb.

---

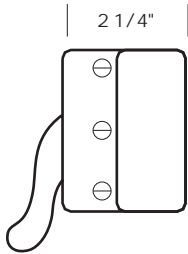

CWL-100LH Left hand window latch with strike.  
Compatible with Truth window mechanism. (Not included).  
Latch mounts directly to window jamb.

---

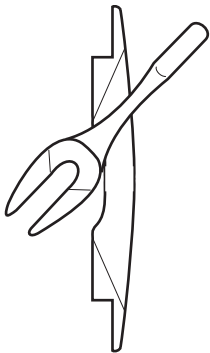

CML-100 Mirage type window latch.  
Compatible with Truth/Mirage window mechanism. (Not included). Latch mounts directly to window jamb.

---

\* Always specify window manufacturer.

**PROPRIETARY AND CONFIDENTIAL:** The information contained in this drawing is the sole property of Sun Valley Bronze. Any reproduction in part or as a whole without the written permission of Sun Valley Bronze is prohibited.

Revised 03/10/11



# CASEMENT WINDOW LATCH

Illustrations are for demonstration purposes only.

**\*Always specify handing.**

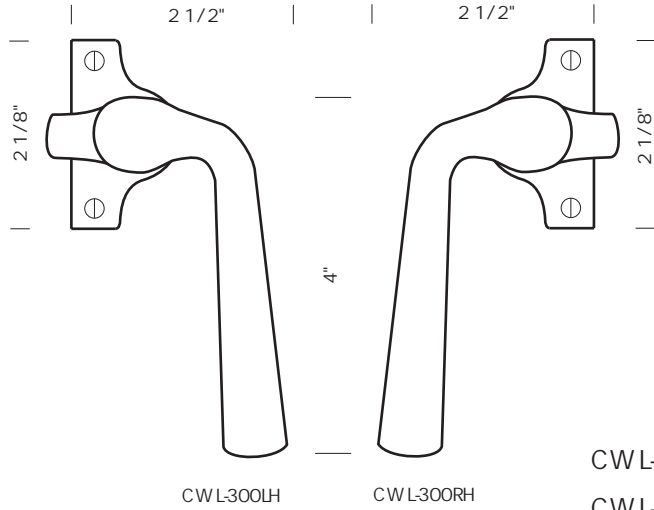

CWL-300LH 2 1/2" x 4" Casement window latch. Left hand.  
 CWL-300RH 2 1/2" x 4" Casement window latch. Right hand.

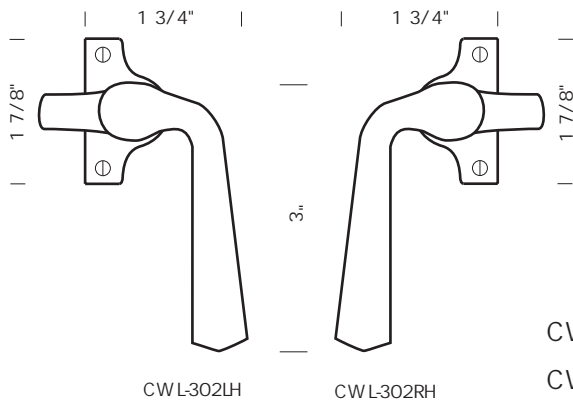

CWL-302LH 1 3/4" x 3" Casement window latch. Left hand.  
 CWL-302RH 1 3/4" x 3" Casement window latch. Right hand.

## Casement window latch strike options. Must be specified:

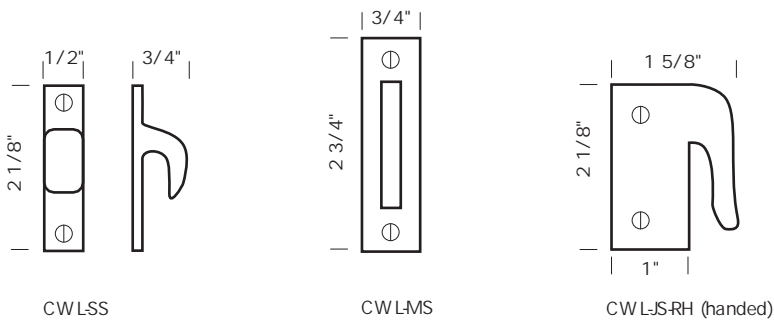

**PROPRIETARY AND CONFIDENTIAL:** The information contained in this drawing is the sole property of Sun Valley Bronze. Any reproduction in part or as a whole without the written permission of Sun Valley Bronze is prohibited.

Revised 03/10/11

SUN VALLEY BRONZE



# CASEMENT WINDOW LATCH

Illustrations are for demonstration purposes only.

**\*Always specify handing.**

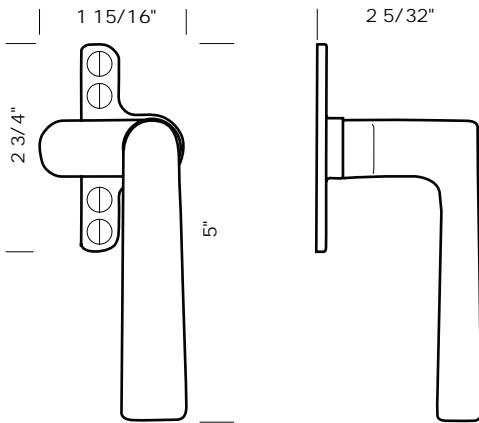

CWL-900LH  
No lever option.

Profile

CWL-900LH 1 15/16" x 5" Casement window latch. Left hand. (Shown).

CWL-900RH 1 15/16" x 5" Casement window latch. Right hand.

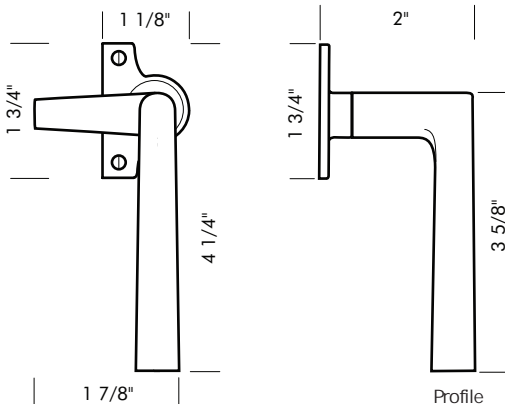

CWL-922LH  
No lever option.

Profile

CWL-922LH 1 7/8" x 4 1/4" Casement window latch. Left hand. (Shown).

CWL-922RH 1 7/8" x 4 1/4" Casement window latch. Right hand.

**Casement window latch strike options. Must be specified:**

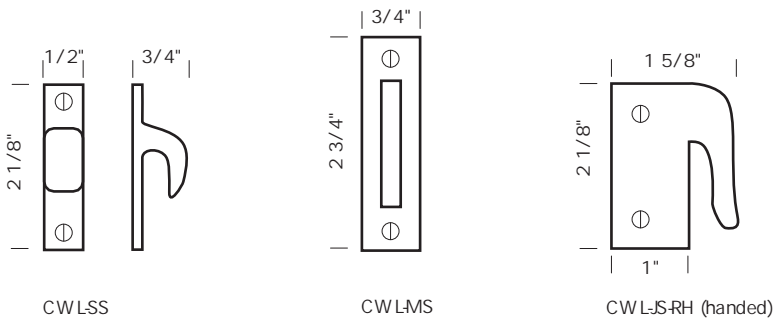

CWLSS

CWLMS

CWLJS-RH (handed)

**PROPRIETARY AND CONFIDENTIAL:** The information contained in this drawing is the sole property of Sun Valley Bronze. Any reproduction in part or as a whole without the written permission of Sun Valley Bronze is prohibited.

Revised 03/10/11

SUN VALLEY BRONZE



# CASEMENT WINDOW LATCH

Illustrations are for demonstration purposes only.

**\*Always specify handing.**

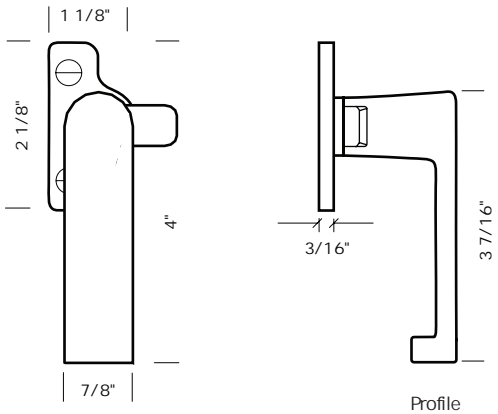

CWL-325LH  
No lever option.

CWL-325LH 1 1/8" x 4" Casement window latch. Left hand. (Shown).

CWL-325RH 1 1/8" x 4" Casement window latch. Right hand.

## Casement window latch strike options. Must be specified:

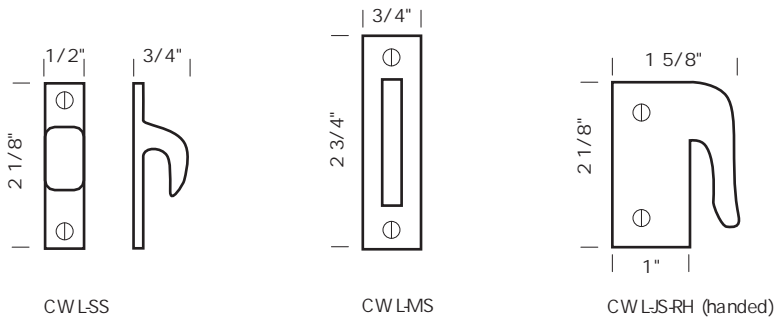

CWLSS

CWLMS

CWLJS-RH (handed)

**PROPRIETARY AND CONFIDENTIAL:** The information contained in this drawing is the sole property of Sun Valley Bronze. Any reproduction in part or as a whole without the written permission of Sun Valley Bronze is prohibited.

Revised 03/10/11



Illustrations are for demonstration purposes only.

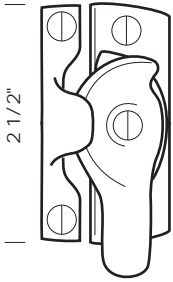

W SL-500

**Sash lock.**

W SL-500 Sash Lock for double hung windows.  
Features spring detent mechanism for smooth yet snug operation.

SUN VALLEY BRONZE

**PROPRIETARY AND CONFIDENTIAL:** The information contained in this drawing is the sole property of Sun Valley Bronze. Any reproduction in part or as a whole without the written permission of Sun Valley Bronze is prohibited.

*Revised 03/10/11*



# MULTI-POINT WINDOW HARDWARE

Illustrations are for demonstration purposes only.

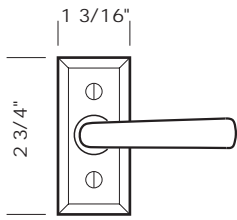

MPW-100

Interior active trim. 1 3/16" x 2 3/4" plate.  
Complete set with spindle. Shown with L-96 lever.  
43mm screw centers to ftGU or similar window gear.  
7mm spindle on square. No 3 point posi-lock.  
Always specify window manufacturer.

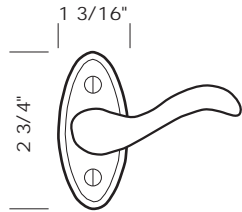

MPW-OP100

Interior active trim. 1 3/16" x 2 3/4" oval plate.  
Complete set with spindle. Shown with L-93 lever.  
43mm screw centers to ftGU or similar window gear.  
7mm spindle on square. No 3 point posi-lock.  
Always specify window manufacturer.

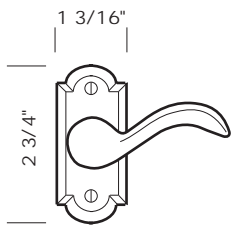

MPW-A100

Interior active trim. 1 3/16" x 2 3/4" plate.  
Complete set with spindle. Shown with L-92 lever.  
43mm screw centers to ftGU or similar window gear.  
7mm spindle on square. No 3 point posi-lock.  
Always specify window manufacturer.

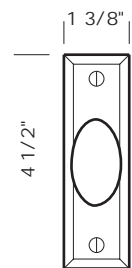

MPW-200

Interior active trim. 1 3/8" x 4 1/2" plate.  
Complete set with spindle. Shown with K-305 knob.  
Plate mounts directly to window frame.  
7mm spindle on square. With 3 point posi-lock.  
Always specify window manufacturer.

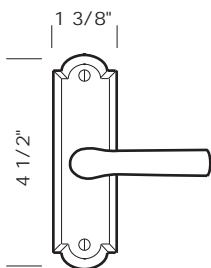

MPW-A200

Interior active trim. 1 3/8" x 4 1/2" plate.  
Complete set with spindle. Shown with L-86 lever.  
Plate mounts directly to window frame.  
7mm spindle on square. With 3 point posi-lock.  
Always specify window manufacturer.

**PROPRIETARY AND CONFIDENTIAL:** The information contained in this drawing is the sole property of Sun Valley Bronze. Any reproduction in part or as a whole without the written permission of Sun Valley Bronze is prohibited.

Revised 03/10/11



# MULTI-POINT WINDOW HARDWARE

Illustrations are for demonstration purposes only.

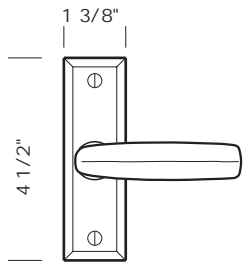

**MPW-300** Interior active trim. 1 3/8" x 4 1/2" plate.  
Complete set with spindle. Shown with L-104 lever.  
Plate mounts directly to window frame.  
7mm spindle on square. With 3 point posi-lock.  
Always specify window manufacturer.

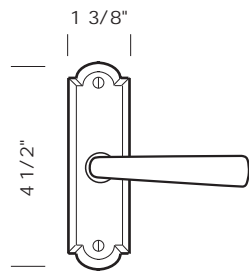

**MPW-A300** Interior active trim. 1 3/8" x 4 1/2" plate.  
Complete set with spindle. Shown with L-106 lever.  
Plate mounts directly to window frame.  
7mm spindle on square. With 3 point posi-lock.  
Always specify window manufacturer.

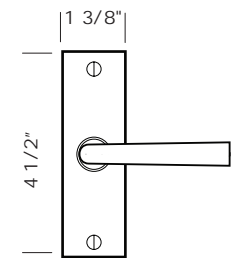

**MPW-9200** Interior active trim. 1 3/8" x 4 1/2" plate.  
Complete set with spindle. 3/4" hub. Requires multi-point lever.  
Shown with L-22 multi-point lever.  
Plate mounts directly to window frame.  
7mm spindle on square. With 3 point posi-lock.  
Always specify window manufacturer.

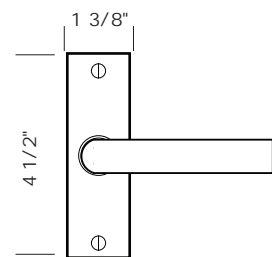

**MPW-9300** Interior active trim. 1 3/8" x 4 1/2" plate.  
Complete set with spindle. 7/8" hub.  
Shown with L-169 lever.  
Plate mounts directly to window frame.  
7mm spindle on square. With 3 point posi-lock.  
Always specify window manufacturer.

**Any full size lever is available with 300 Series Multi-point hardware. Please specify.**

Plate mounts directly to window frame.  
7mm spindle on square.  
With 3 point posi-lock.  
Always specify window manufacturer.

**PROPRIETARY AND CONFIDENTIAL:** The information contained in this drawing is the sole property of Sun Valley Bronze. Any reproduction in part or as a whole without the written permission of Sun Valley Bronze is prohibited.

Revised 03/10/11



# MULTI-POINT WINDOW HARDWARE

Illustrations are for demonstration purposes only.

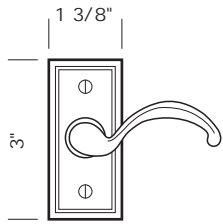

MPW-121 Interior active trim.  
1 3/8" x 3" plate.  
Complete set with spindle.  
Shown with L-20 lever.

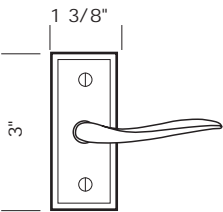

MPW-1500 Interior active trim.  
1 3/8" x 3" plate.  
Complete set with spindle.  
Shown with L-26 lever.

**Any full size lever is available with 300 Series Multi-point hardware. Please specify.**

Plate mounts directly to window frame.  
7mm spindle on square.  
With 3 point posi-lock.  
Always specify window manufacturer.

SUN VALLEY BRONZE

**PROPRIETARY AND CONFIDENTIAL:** The information contained in this drawing is the sole property of Sun Valley Bronze. Any reproduction in part or as a whole without the written permission of Sun Valley Bronze is prohibited.

Revised 03/10/11



# 100 & 200 SERIES MULTI-POINT LEVER OPTIONS

Illustrations are for demonstration purposes only. Any screen door lever may be substituted for lever shown.

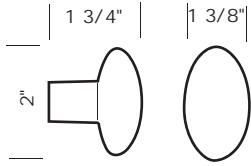

K-305 Mini Egg

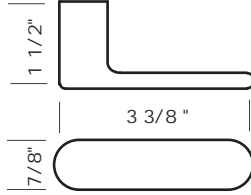

L-11 Mini Flat

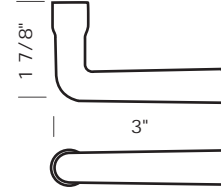

L-12 Tiny Tube

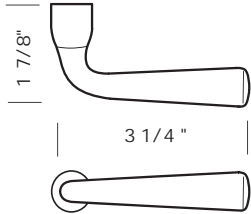

L-13 Mini Alturas

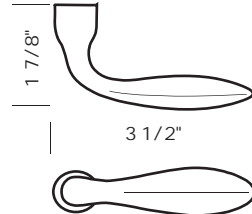

L-16 Mini Quigley

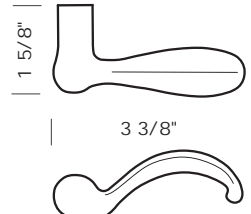

L-20 Mini Croy

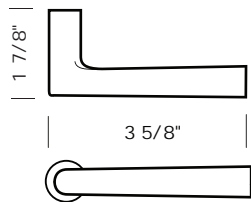

L-22 Mini Metro

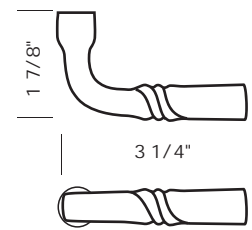

L-23 Mini Twist

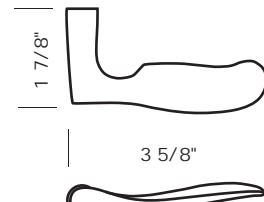

L-26 Mini Silver Creek

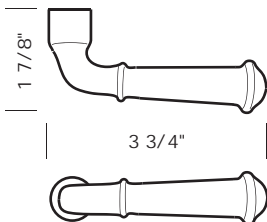

L-27 Mini Hailey

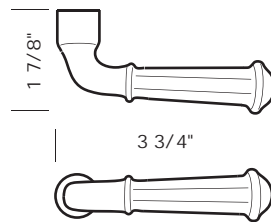

L-28 Mini Stanley

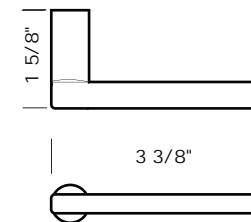

L-29 Mini Della

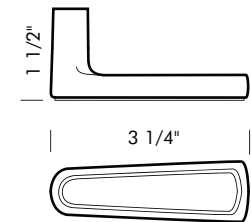

L-48 Mini Ridge

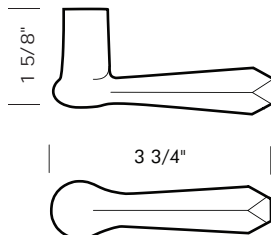

L-70 Mini Preston

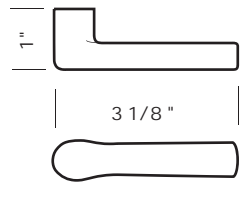

L-86 Tadpole

SUN VALLEY BRONZE

**PROPRIETARY AND CONFIDENTIAL:** The information contained in this drawing is the sole property of Sun Valley Bronze. Any reproduction in part or as a whole without the written permission of Sun Valley Bronze is prohibited.

Revised 03/10/11



# 100 & 200 SERIES MULTI-POINT LEVER OPTIONS

Illustrations are for demonstration purposes only. Any screen door lever may be substituted for lever shown.

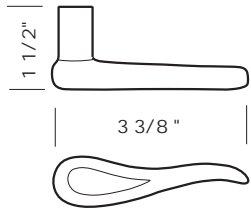

L91 Little Horn

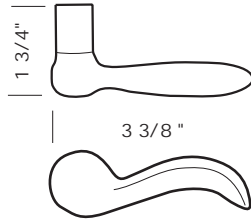

L92 Lil' Squirrel

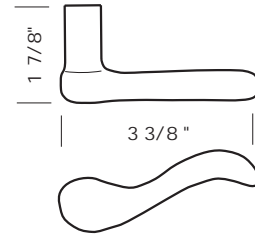

L93 Chubster

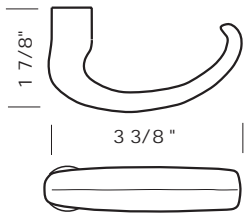

L94 Little Hook

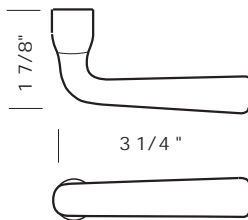

L96 Squarelet

SUN VALLEY BRONZE

**PROPRIETARY AND CONFIDENTIAL:** The information contained in this drawing is the sole property of Sun Valley Bronze. Any reproduction in part or as a whole without the written permission of Sun Valley Bronze is prohibited.

Revised 03/10/11

