

811 PRO FILE CYLINDER SLIDING DOOR RETROFIT SETS

Illustrations are for demonstration purposes only. Any lever may be substituted for lever shown.

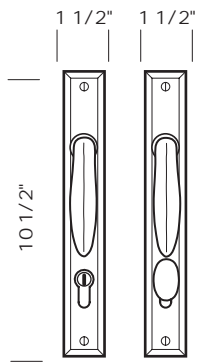

CMP-811SL
 -Complete set with keyed profile cylinder,
 SVB turn piece and spindle.
 -Single cylinder.
 -Shown with L-107 lever.

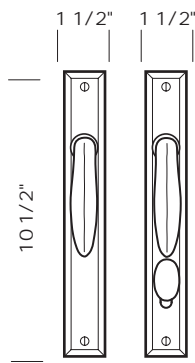

CMP-811SLPF
 -Complete set with 1/2 profile cylinder,
 SVB turn piece and spindle.
 -Patio function.
 -Shown with L-107 lever.

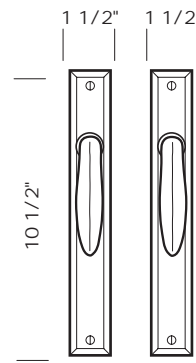

CMP-811SLFD
 -Trim set only.
 -Full dummy.
 -Shown with L-107 lever.

Complete sliding door sets with plates, levers, profile cylinder, and spindle. No lock included. 122 mm spacing.

CMP-811SL Single cylinder. Euro slider set (key x turn piece).
 1 1/2" x 10 1/2" plates

CMP-811SLPF Patio function. Euro slider set (Turn piece only).

CMP-811SLFD Full dummy. Fixed levers.

Door handing and thickness is required for all Sliding Door Retrofit Sets.

Always specify lever design.

Re-keying to other cylinders is not available.

***Always specify door manufacturer.**

SUN VALLEY BRONZE

PROPRIETARY AND CONFIDENTIAL: The information contained in this drawing is the sole property of Sun Valley Bronze. Any reproduction in part or as a whole without the written permission of Sun Valley Bronze is prohibited.

Revised 08/19/10



A811 PRO FILE CYLINDER SLIDING DOOR RETROFIT SETS

Illustrations are for demonstration purposes only. Any lever may be substituted for lever shown.

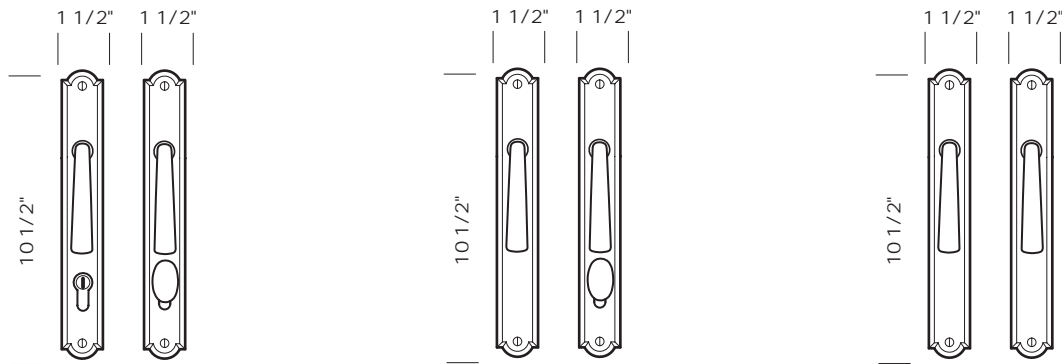

CMPA811SL
 -Complete set with keyed profile cylinder, SVB turn piece, and spindle.
 -Single cylinder.
 -Shown with L-106 lever.

CMPA811SL-PF
 -Complete set with 1/2 profile cylinder, SVB turn piece and spindle.
 -Patio function.
 -Shown with L-106 lever.

CMPA811SL-FD
 -Trim set only.
 -Full dummy.
 -Shown with L-106 lever.

Complete sliding door sets with plates, levers, profile cylinder, and spindle. No lock included. 122 mm spacing.

CMPA811SL Single cylinder. Euro slider set (key x turn piece).
 1 1/2" x 10 1/2" plates

CMPA811SL-PF Patio function. Euro slider set (Turn piece only).

CMPA811SL-FD Full dummy. Fixed levers.

Door handing and thickness is required for all Sliding Door Retrofit Sets.

Always specify lever design.

Re-keying to other cylinders is not available.

***Always specify door manufacturer.**

SUN VALLEY BRONZE

PROPRIETARY AND CONFIDENTIAL: The information contained in this drawing is the sole property of Sun Valley Bronze. Any reproduction in part or as a whole without the written permission of Sun Valley Bronze is prohibited.

Revised 08/19/10



812 PRO FILE CYLINDER SLIDING DOOR RETROFIT SETS

Illustrations are for demonstration purposes only. Any lever may be substituted for lever shown.

***Always verify backset compatibility when specifying wide plates.**

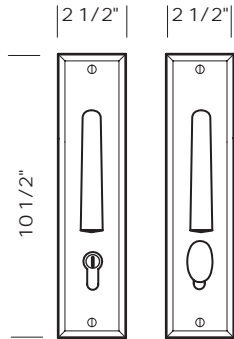

CMP-812SL
 -Complete set with keyed profile cylinder,
 SVB turn piece and spindle.
 -Single cylinder.
 -Shown with L-133 lever.

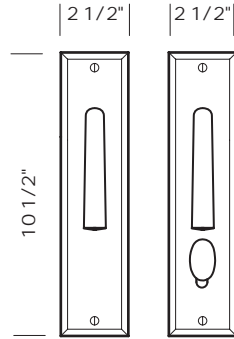

CMP-812SLPF
 -Complete set with 1/2 profile cylinder,
 SVB turn piece and spindle.
 -Patio function.
 -Shown with L-133 lever.

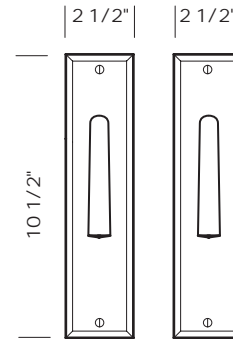

CMP-812SLFD
 -Trim set only.
 -Full dummy.
 -Shown with L-133 lever.

Complete sliding door sets with plates, levers, profile cylinder, and spindle. No lock included. 122 mm spacing.

CMP-812SL Single cylinder. Euro slider set (key x turn piece).
 2 1/2" x 10 1/2" plates.

CMP-812SLPF Patio function. Euro slider set (Turn piece only).

CMP-812SLFD Full dummy. Fixed levers.

Door handing and thickness is required for all Sliding Door Retrofit Sets.

Always specify lever design.

Re-keying to other cylinders is not available.

***Always specify door manufacturer.**

SUN VALLEY BRONZE

PROPRIETARY AND CONFIDENTIAL: The information contained in this drawing is the sole property of Sun Valley Bronze. Any reproduction in part or as a whole without the written permission of Sun Valley Bronze is prohibited.

Revised 08/19/10



A 812 PRO FILE CYLINDER SLIDING DOOR RETROFIT SETS

Illustrations are for demonstration purposes only. Any lever may be substituted for lever shown.

***Always verify backset compatibility when specifying wide plates.**

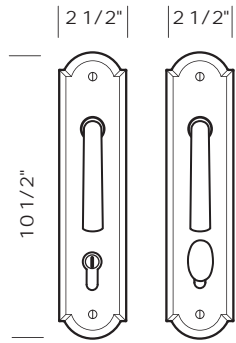

CMPA812SL
 -Complete set with keyed profile cylinder,
 SVB turn piece and spindle.
 -Single cylinder.
 -Shown with L-112 lever.

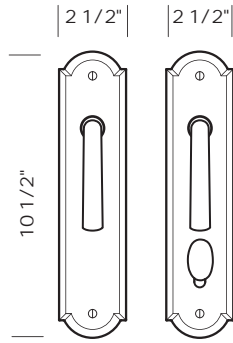

CMPA812SL-PF
 -Complete set with 1/2 profile cylinder,
 SVB turn piece and spindle.
 -Patio function.
 -Shown with L-112 lever.

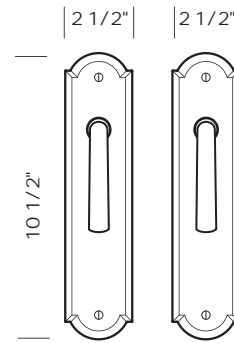

CMPA812SL-FD
 -Trim set only.
 -Full dummy.
 -Shown with L-112 lever.

Complete sliding door sets with plates, levers, profile cylinder, and spindle. No lock included. 122 mm spacing.

CMPA812SL Single cylinder. Euro slider set (Key x turn piece).
 2 1/2" x 10 1/2" plates

CMPA812SL-PF Patio function. Euro slider set (Turn piece only).

CMPA812SL-FD Full dummy. Fixed levers.

Door handing and thickness is required for all Sliding Door Retrofit Sets.

Always specify lever design.

Re-keying to other cylinders is not available.

***Always specify door manufacturer.**

SUN VALLEY BRONZE

PROPRIETARY AND CONFIDENTIAL: The information contained in this drawing is the sole property of Sun Valley Bronze. Any reproduction in part or as a whole without the written permission of Sun Valley Bronze is prohibited.

Revised 08/19/10



980 PRO FILE CYLINDER SLIDING DOOR RETROFIT SETS

Illustrations are for demonstration purposes only. Any lever may be substituted for lever shown.

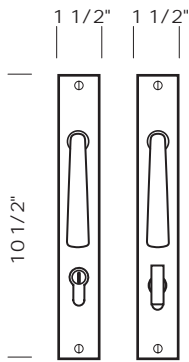

CMP-980SL
 -Complete set with keyed profile cylinder, SVB turn piece, and spindle.
 -Single cylinder.
 -Shown with L-106 lever.

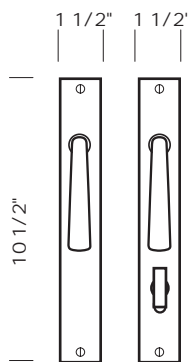

CMP-980SL-PF
 -Complete set with 1/2 profile cylinder, SVB turn piece, and spindle.
 -Patio function.
 -Shown with L-106 lever.

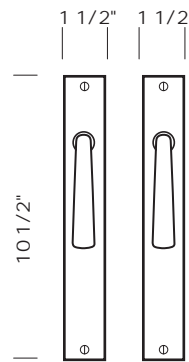

CMP-980SL-FD
 -Trim set only.
 -Full dummy.
 -Shown with L-106 lever.

Complete sliding door sets with plates, levers, profile cylinder, and spindle. No lock included. 122 mm spacing.

CMP-980SL Single cylinder. Euro slider set (Key x turn piece).
 1 1/2" x 10 1/2" plates

CMP-980SL-PF Patio function. Euro slider set (Turn piece only).

CMP-980SL-FD Full dummy. Fixed levers.

Door handing and thickness is required for all Sliding Door Retrofit Sets.

Always specify lever design.

Re-keying to other cylinders is not available.

***Always specify door manufacturer.**

SUN VALLEY BRONZE

PROPRIETARY AND CONFIDENTIAL: The information contained in this drawing is the sole property of Sun Valley Bronze. Any reproduction in part or as a whole without the written permission of Sun Valley Bronze is prohibited.

Revised 08/19/10



982 PRO FILE CYLINDER SLIDING DOOR RETROFIT SETS

Illustrations are for demonstration purposes only. Any lever may be substituted for lever shown.

***Always verify backset compatibility when specifying wide plates.**

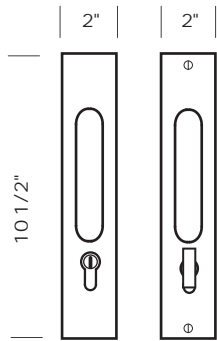

CMP-982SL

-Complete set with keyed profile cylinder, SVB turn piece, and spindle.
-Single cylinder.
-Shown with L-111 lever.

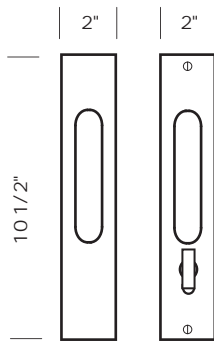

CMP-982SL-PF

-Complete set with 1/2 profile cylinder, SVB turn piece, and spindle.
-Patio function.
-Shown with L-111 lever.

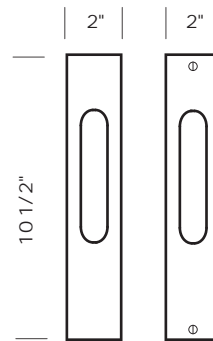

CMP-982SL-FD

-Trim set only.
-Full dummy.
-Shown with L-111 lever.

Complete sliding door sets with plates, levers, profile cylinder, and spindle. No lock included. 122 mm spacing.

CMP-982SL Single cylinder. Euro slider set (key x turn piece).
2" x 10 1/2" plates

CMP-982SL-PF Patio function. Euro slider set (Turn piece only).

CMP-982SLAD Full dummy. Fixed levers.

Door handing and thickness is required for all Sliding Door Retrofit Sets.

Always specify lever design.

Re-keying to other cylinders is not available.

***Always specify door manufacturer.**

SUN VALLEY BRONZE

PROPRIETARY AND CONFIDENTIAL: The information contained in this drawing is the sole property of Sun Valley Bronze. Any reproduction in part or as a whole without the written permission of Sun Valley Bronze is prohibited.

Revised 08/19/10



816 US CYLINDER SLIDING DOOR RETROFIT SETS

Illustrations are for demonstration purposes only.

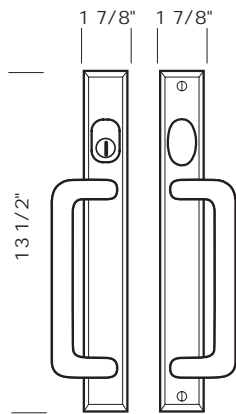

CMPUS-816SL
-Complete set with keyed US cylinder,
and turn piece.
-Single cylinder.

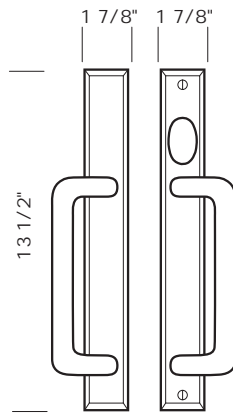

CMPUS-816SLPF
-Complete set with turn piece.
-Patio function.

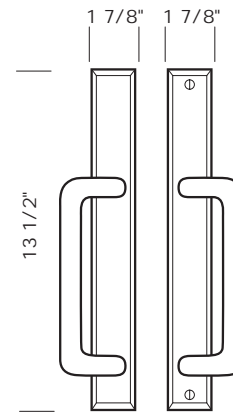

CMPUS-816SLFD
-Trim set only.
-Full dummy.

Complete sliding door sets with plates, D handles and US cylinder. No lock included.

CMPUS-816SL Single cylinder. US cylinder slider set (Key x turn piece).
1 7/8" x 13 1/2" plates.

CMPUS-816SLPF Patio function. US cylinder slider set (Turn piece only).

CMPUS-816SLFD Full dummy.

Door handing and thickness is required for all Sliding Door Retrofit Sets.

All cylinders are 5 pin Schlage C keyways.

Re-keying to other cylinders is available.

***Always specify door manufacturer as tailpiece configurations do vary.**

SUN VALLEY BRONZE

PROPRIETARY AND CONFIDENTIAL: The information contained in this drawing is the sole property of Sun Valley Bronze. Any reproduction in part or as a whole without the written permission of Sun Valley Bronze is prohibited.

Revised 08/19/10



