

CONTENTS

This section contains Door Knobs, Ring Pulls, Levers, Escutcheons, Turn Pieces and Key Covers. Dimensions given in this section are for actual levers or knobs only. To calculate overall depth from face of door to outside of lever or knob, add 5/8" to shaft length for 900 and 1200 series plates, and 1/2" for all other plates. The shaft on any knob or lever can be extended up to 2" to accommodate blinds or other special applications.

TABLE OF CONTENTS:

<u>Knobs</u>	<u>Pages 2-2 - 2-7</u>
<u>Ring Pulls</u>	<u>Page 2-8</u>
<u>Levers</u>	<u>Pages 2-9 - 2-18</u>
<u>Inlay Knobs</u>	<u>Page 2-19</u>
<u>Wood Handle & Inlay Levers</u>	<u>Page 2-20</u>
<u>Hand Peened Knobs & Levers</u>	<u>Page 2-21</u>
<u>Art Glass Knobs</u>	<u>Page 2-22</u>
<u>Escutcheon Plates & Rosettes</u>	<u>Pages 2-23 - 2-39</u>
<u>Turn Piece Options</u>	<u>Page 2-40</u>
<u>Key Covers</u>	<u>Page 2-41</u>



Illustrations are for demonstration purposes only.

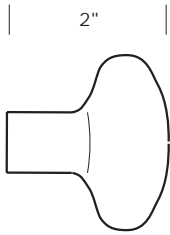

K-201 MUSHROOM™

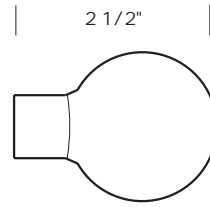
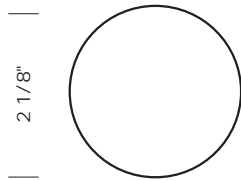

K-202 HITCH™

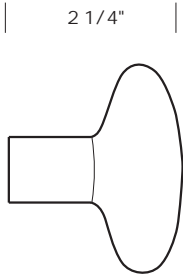
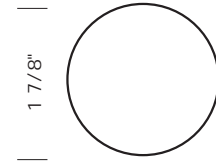

K-203 SPUD™

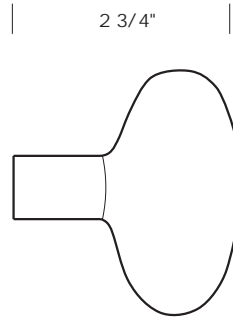
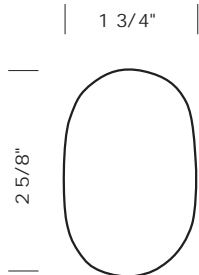

K-205-BAKER™

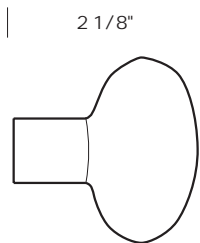
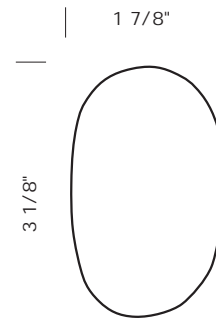

K-206 SMALL EGG

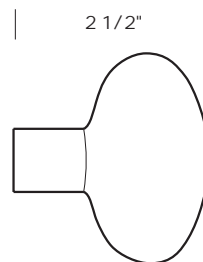
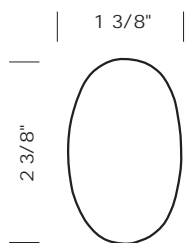

K-207 LARGE EGG

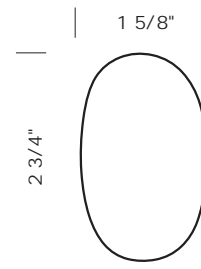

PROPRIETARY AND CONFIDENTIAL: The information contained in this drawing is the sole property of Sun Valley Bronze. Any reproduction in part or as a whole without the written permission of Sun Valley Bronze is prohibited.

Revised 02/02/11



Illustrations are for demonstration purposes only.

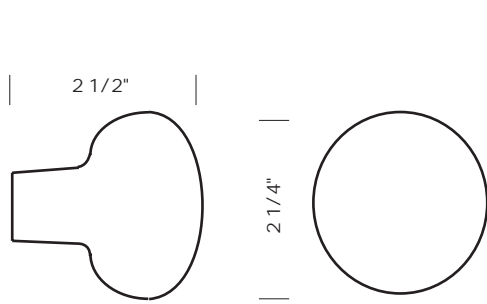

K-208 BOB

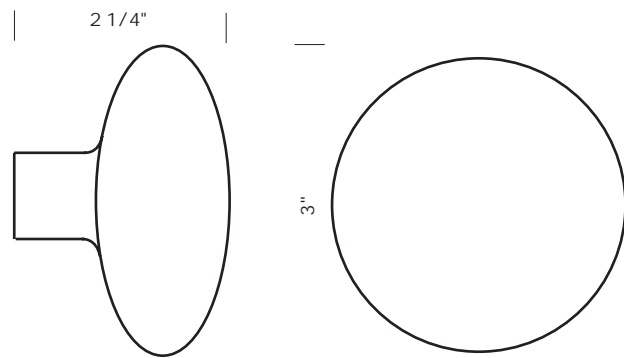

K-209 PORTABELLO

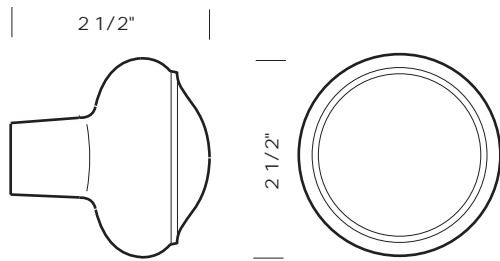

K-214 RIDGE

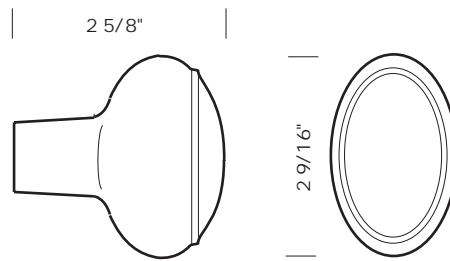

K-215 OVAL RIDGE

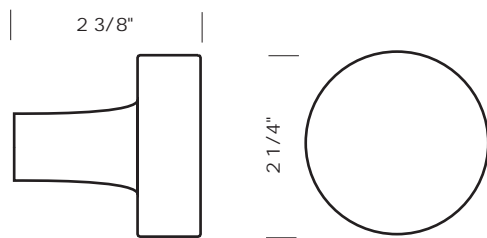

K-217 FLAT

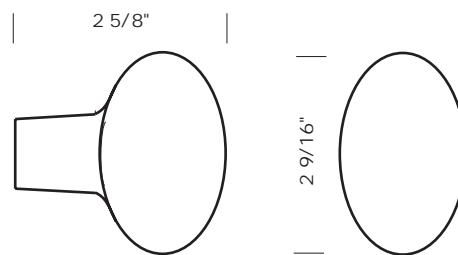

K-220 OVAL

SUN VALLEY BRONZE

PROPRIETARY AND CONFIDENTIAL: The information contained in this drawing is the sole property of Sun Valley Bronze. Any reproduction in part or as a whole without the written permission of Sun Valley Bronze is prohibited.

Revised 02/02/11



Illustrations are for demonstration purposes only.

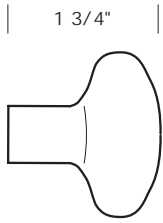

K-221 MINI MUSHROOM

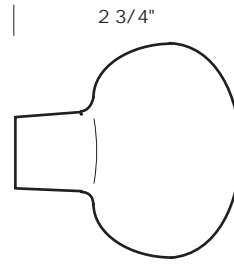
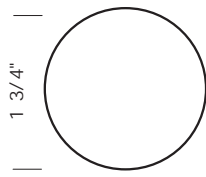

K-222 BIG BOB KNOB

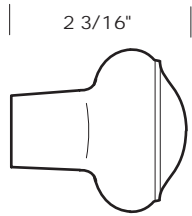
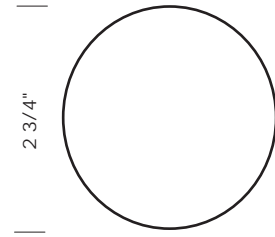

K-224 SMALL RIDGE

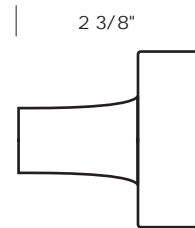
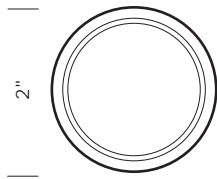

K-225 SQUARE

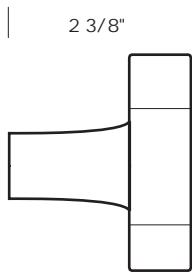
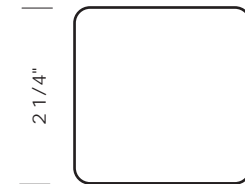

K-226 OCTAGON

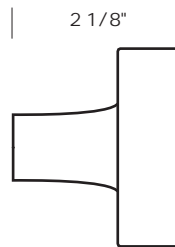
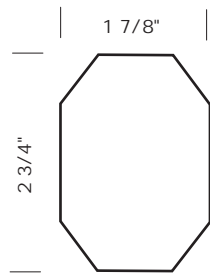

K-227 LARGE FLAT

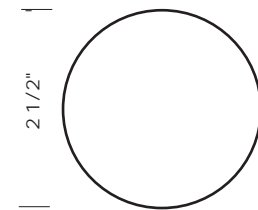

PROPRIETARY AND CONFIDENTIAL: The information contained in this drawing is the sole property of Sun Valley Bronze. Any reproduction in part or as a whole without the written permission of Sun Valley Bronze is prohibited.

Revised 02/02/11



Illustrations are for demonstration purposes only.

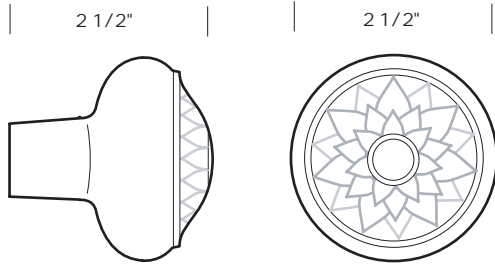

K-230 ARTICHOKE KNOB

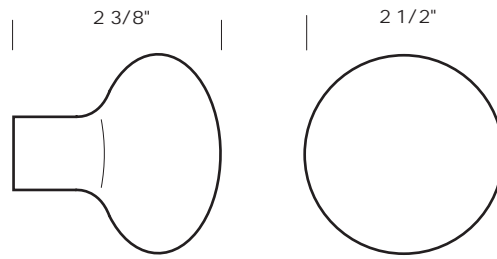

K-231 CHALLIS KNOB

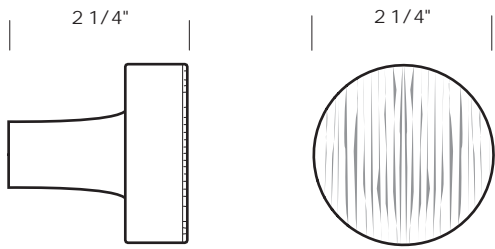

K-233 CORDUROY FLAT KNOB

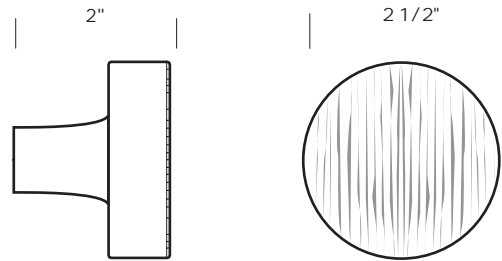

K-234 CORDUROY LARGE FLAT KNOB

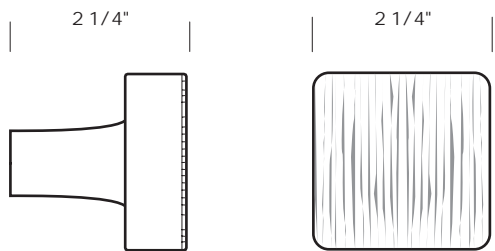

K-235 CORDUROY SQUARE KNOB

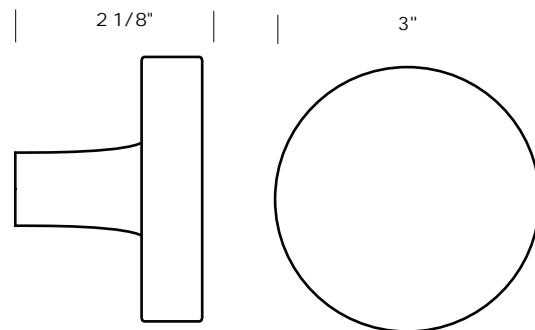

K-237 LARGE FLAT

PROPRIETARY AND CONFIDENTIAL: The information contained in this drawing is the sole property of Sun Valley Bronze. Any reproduction in part or as a whole without the written permission of Sun Valley Bronze is prohibited.

Revised 02/02/11



Illustrations are for demonstration purposes only.

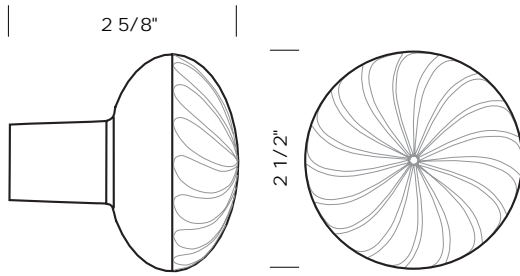

K-238 ROUND GIRO KNOB

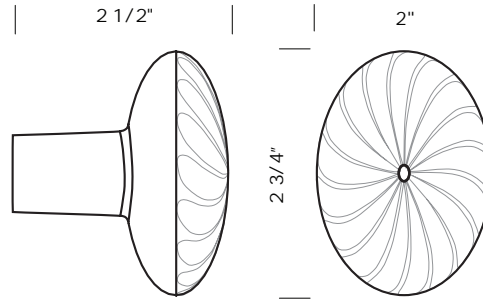

K-239 OVAL GIRO KNOB

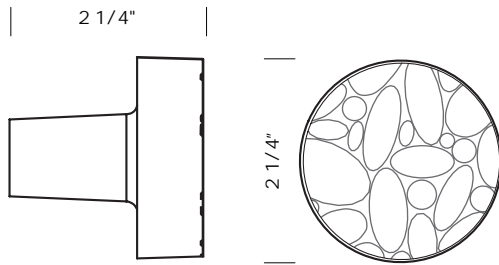

K-240 STONE KNOB

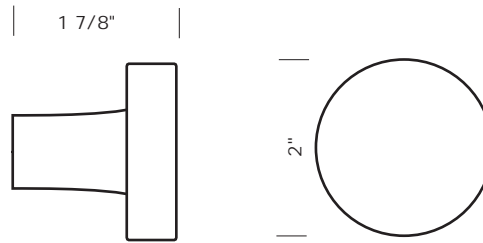

K-247 SMALL FLAT KNOB

PROPRIETARY AND CONFIDENTIAL: The information contained in this drawing is the sole property of Sun Valley Bronze. Any reproduction in part or as a whole without the written permission of Sun Valley Bronze is prohibited.

Revised 02/02/11



Illustrations are for demonstration purposes only.

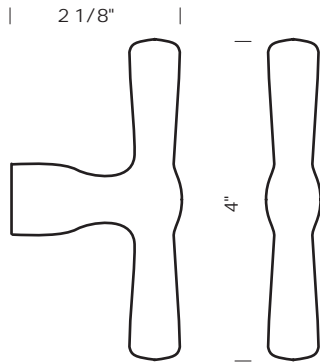

K-227-T SMALL T

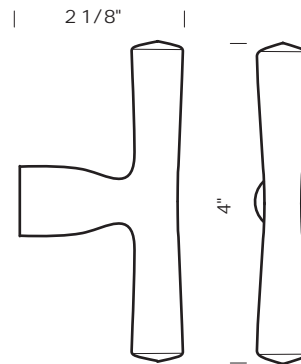

K-228-T SMALL T

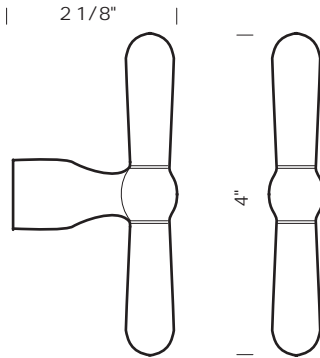

K-229-T SMALL T

PROPRIETARY AND CONFIDENTIAL: The information contained in this drawing is the sole property of Sun Valley Bronze. Any reproduction in part or as a whole without the written permission of Sun Valley Bronze is prohibited.

Revised 02/02/11



Illustrations are for demonstration purposes only.

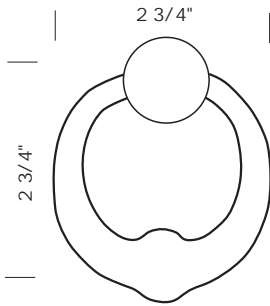

K-210 RING PULL

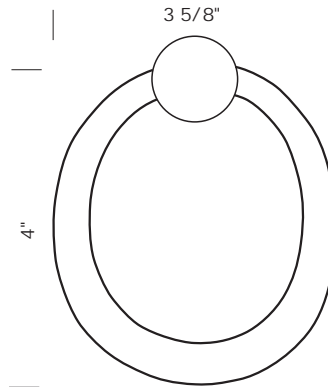

K-211 RING PULL

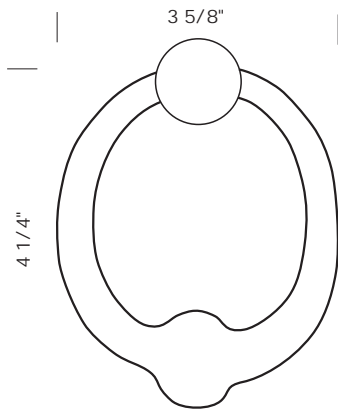

K-212 RING PULL

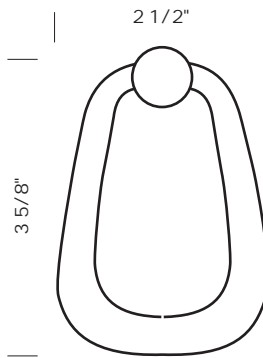

K-213 RING PULL

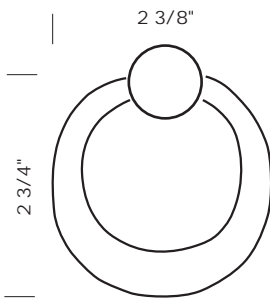

K-216 RING PULL

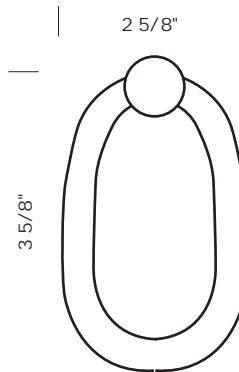

K-218 RING PULL

PROPRIETARY AND CONFIDENTIAL: The information contained in this drawing is the sole property of Sun Valley Bronze. Any reproduction in part or as a whole without the written permission of Sun Valley Bronze is prohibited.

Revised 02/02/11



Illustrations are for demonstration purposes only.



5 3/4"

L-101 LONGHORN™

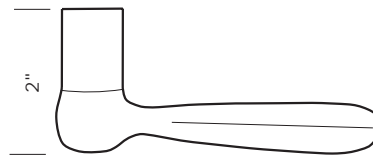

4 3/4"

L-102 SQUIRREL TAIL™

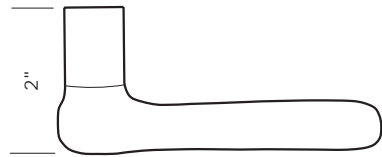

4 1/2"

L-103 CHUB™

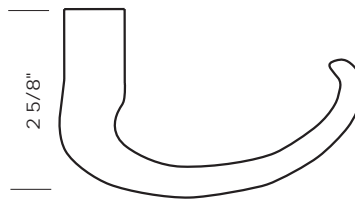

4 1/4"

L-104 SMALL HOOK



5 1/4"

L-105 BEAVER TAIL™

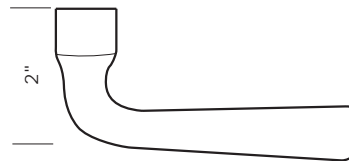

4 1/4"

L-106 SQUARE

SUN VALLEY BRONZE

PROPRIETARY AND CONFIDENTIAL: The information contained in this drawing is the sole property of Sun Valley Bronze. Any reproduction in part or as a whole without the written permission of Sun Valley Bronze is prohibited.

Revised 02/02/11



Illustrations are for demonstration purposes only.

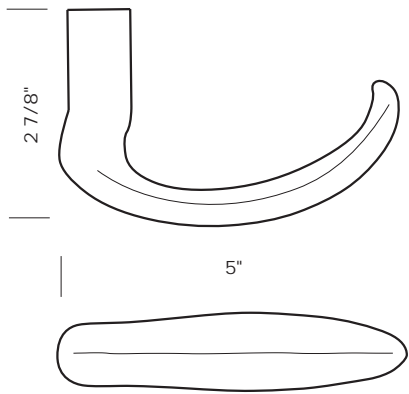

L-107 LARGE HOOK

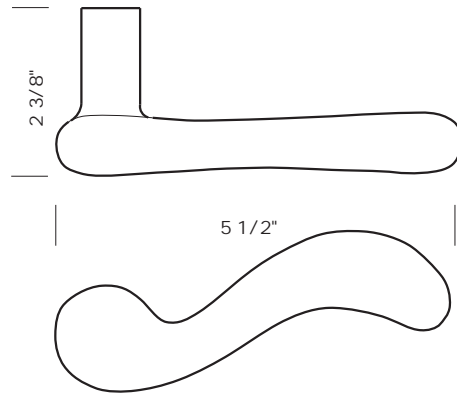

L-108 CHUBBA™

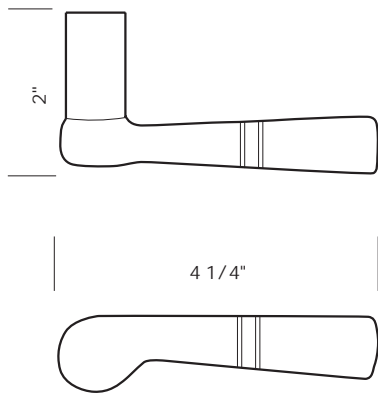

L-109 RING TAIL

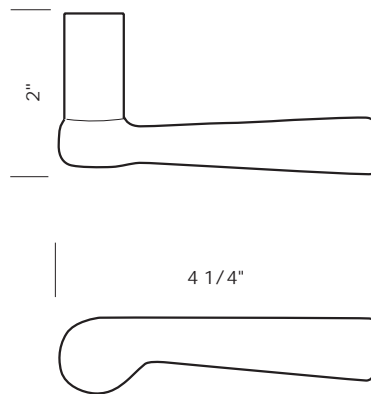

L-110 BALDY

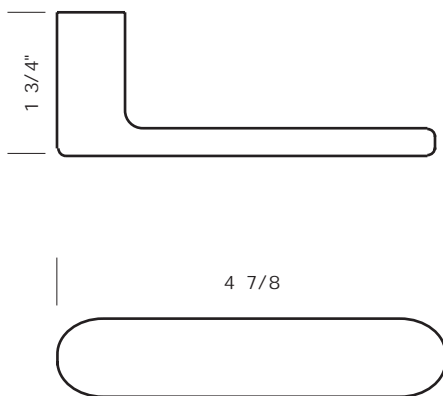

L-111 FLAT

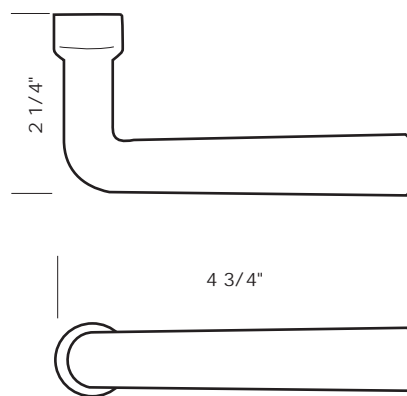

L-112 TUBE

SUN VALLEY BRONZE

PROPRIETARY AND CONFIDENTIAL: The information contained in this drawing is the sole property of Sun Valley Bronze. Any reproduction in part or as a whole without the written permission of Sun Valley Bronze is prohibited.

Revised 02/02/11



